

# Beton Wood

Description of Application Technology

CEMENT BONDED CHIPBOARD BETONWOOD®

Edition 2012



## Introduction

BETONWOOD<sup>®</sup> S.r.l. produces chipboards for furniture industry and also special chipboards for the building industry besides.

This cement-bonded chipboard product was given the trade mark BetonWood<sup>®</sup>.

Experiences gained in about two decades show that the cement-bonded chipboard meets the user's requirements and finds more and more widening applications among the modern building materials. Due to its advantageous properties, the product has become one of the most important basic materials in lightweight construction.

Due to its excellent properties the export of cement bonded chipboards also takes a prominent part besides the domestic sales:

- Holzforschung Austria, Vienna – Tests for the strenght values of the BETONWOOD<sup>®</sup> boards two times a year.
- FMPA, Otto-Graf-Institut-Universitat, Stuttgart- Accidentally checks for fire resistance and strenght properties.
- IBBF, Ingenieurburo + Bio-Bauforschung Karl Heinz Sirtl – Their tests approve that the application of BETONWOOD<sup>®</sup> building boards don't results any damage in the human or other living organism and in the environment.

The booklet describes in details:

- The physical, mechanical and other properties of the BETONWOOD<sup>®</sup> building boards
- The basic construction principles of structures
- Possible bonding and finishing methods

Main properties of BETONWOOD<sup>®</sup> building boards:

- Incombustible (Bs1D0 -BfIS1 EN 13501-2 )
- Weatherproof
- Fungiproof
- Formaldehyde – and asbestos free

## BETONWOOD<sup>®</sup> Contents

1. Application of the BETONWOOD<sup>®</sup> building boards
2. Main properties, package, transportation and storage of the BETONWOOD<sup>®</sup> building boards
3. Physical properties of the BETONWOOD<sup>®</sup> building boards
4. Machining, fixing, jointing, bonding and finishing of the BETONWOOD<sup>®</sup> building board
5. Basic principles of the BETONWOOD<sup>®</sup> structures
6. Additional information on constructions made of BETONWOOD<sup>®</sup> building boards

## 1. Application of the BETONWOOD<sup>®</sup> building boards

The company BETONWOOD<sup>®</sup> S.r.l. and its predecessor have produced cement bonded chipboards for the building industry with the trade mark BETONWOOD<sup>®</sup>

At special request the BETONWOOD<sup>®</sup> building boards are workable as follows:

- Sanding
- Cut to size
- Edge machining
- Boring

Using BETONWOOD<sup>®</sup> building boards the following products can be made:

- Sopraelevate Floor
- Shuttering systems
- External claddings
- Internal claddings
- Fire-retardant claddings
- Floor coverings
- External load-bearing walls
- Internal load-bearing walls
- Self-supporting walls
- Load-bearing floor slabs
- Suspended ceilings
- Fire-resistant suspended ceilings

The BETONWOOD<sup>®</sup> building boards can be used in wood panel structures for the following buildings, e.g.:

- Public institutions
- Commercial insitutions
- Educational institutions
- Public healths institutions
- Entertainment centres
- Family-dwelling-houses
- Country houses
- Warehouses

The application of different panel and building structures is practicable by individuel planning. This planning has to take into consideration the physical, mechanical and thermodynamical characteristics of the BETONWOOD<sup>®</sup> building boards and the principles of the construction building.

(These principles are described circumstantially later on)

BETONWOOD<sup>®</sup> also manufactures flooring systems in addition to building boards.

## 2. Main properties, package, transportation and storage of the BETONWOOD<sup>®</sup> building boards

### 2.1 DEFINITION

The cement bonded chipboard is a board product made in flat press from reduced wood material, wood chips with addition of hydraulic binder (portland cement) and chemical additive for application in the building industry.

## 2.2 MAIN PROPERTIES OF THE BETONWOOD<sup>®</sup> BUILDING BOARDS

The BETONWOOD<sup>®</sup> building boards combines the advantageous properties of cement with those of wood particles treated with chemical additives. The board structure is continuously layered from the finer wood chip fraction forming the upper layer on both sides to the central coarser layer.

The board surfaces are smooth, their colour is cement grey.

The BETONWOOD<sup>®</sup> board is lighter than the traditional building materials. It is weather and frost resistant. Insects and fungus do not attack and damage it. Due to the excellent physical and mechanical properties it is one of the most important basic materials in lightweight building.

## 2.3 PACKAGE OF THE BETONWOOD<sup>®</sup> BUILDING BOARDS

The cement bonded chipboards are packed in the factory on supporting timbers or on pallets in unit stacks.

A protective cover sheet on top at the bottom of the stack is made of a lower grade chipboard. The stacks are clamped with steel or plastic ciklostrip. The edge of cement-bonded chipboards under ciklostrip are fitted up with edge-protectors. The total weight of an average stack is appr. 3200-3500 kg.

Thickness	Boards quantity	Building boards dimension						Note
		3200 x 1250 mm		2800 x 1250 mm		2600 x 1250 mm		
		m <sup>2</sup>	m <sup>3</sup>	m <sup>2</sup>	m <sup>3</sup>	m <sup>2</sup>	m <sup>3</sup>	
8 mm	70	280	2,24	245	1,96	228	1,82	
10 mm	60	240	2,40	210	2,10	195	1,95	
12 mm	50	200	2,40	175	2,10	163	1,95	
14 mm	40	160	2,24	140	1,96	130	1,82	
16 mm	35	140	2,24	123	1,96	114	1,82	
18 mm	30	120	2,16	105	1,89	98	1,76	
20 mm	30	120	2,40	105	2,10	98	1,95	
22 mm	25	100	2,20	88	1,93	81	1,79	Special
24 mm	25	100	2,40	88	2,10	81	1,95	
28 mm	20	80	2,24	70	1,96	65	1,82	
30 mm	20	80	2,40	70	2,10	65	1,95	Special
32 mm	20	80	2,56	70	2,24	65	2,08	Special
36 mm	15	60	2,16	53	1,89	49	1,76	Special
40 mm	15	60	2,40	53	2,10	49	1,95	

**Table 1.** Standard dimension of BetonWood<sup>®</sup> building boards

## 2.4 TRANSPORTATION OF THE BETONWOOD<sup>®</sup> BUILDING BOARDS

The ready for delivery unit stacks can be transported by rail or by truck. As the loading is made mechanically by BETONWOOD<sup>®</sup> S.r.l., the addressee should be in possession of mechanical unloading equipment, too. Further transportation and unloading are to be organized by the customer.

## 2.5 STORAGE OF THE BETONWOOD<sup>®</sup> BUILDING BOARDS

Proper storage:

- The boards should be stacked by placing them on square supporting timber. To avoid deflection, intermediate supports should be provided. The total board length should be supported with timbers placed at least at four points with uniform spacing. The maximum distance between timbers can be 800 mm.
- When handling individual the BETONWOOD<sup>®</sup> building boards, set them on their edge.
- The stack should be protected against dust and moisture with canvas or foil.
- The stacks should also be protected against soil moisture.
- Avoid storage of boards on edge.
- After using up a stack partially the protective cover board has to be placed back and a ballast should be placed on top of the remained stack in order that to avoid the distortion of the upper boards.
- Avoid to store the building boards on their edge.
- Building boards can not be exposed to direct sunshine during storage.

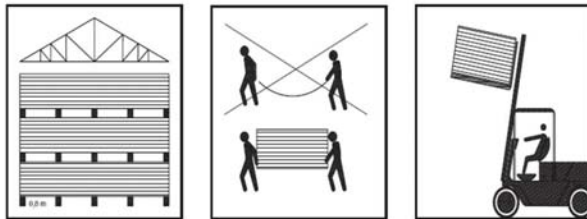

**Picture 1.**

Storage of BETONWOOD<sup>®</sup> building boards

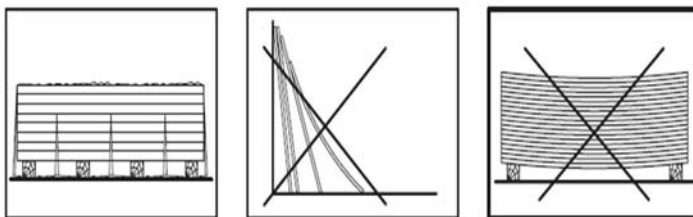

**Picture 2.**

Correct and wrong storage of BETONWOOD<sup>®</sup> building boards

### 3. Material properties of the BETONWOOD® building boards

<u>PROPERTY</u>	<u>VALUE:</u>
Degree of humidity after air-conditioning:	6 – 12 %
Bending strenght:	min. 9 N/mm <sup>2</sup>
Tensile strenght perpendicular to board:	min. 0,5 N/mm <sup>2</sup>
Modulus of bending strenght:	1 stc.: 4500 N/mm <sup>2</sup> 2 ndc.: 4000 N/mm <sup>2</sup>
Swelling of thickness:	1,5 % after 24 hours wetting
Change of lenght and width upon	max 0,3% at a temperature of 20°C
Effectted by humidity*:	rel humidity increasing from 25% to 90%
Coefficient of thermal expansion*:	10-5/K
Conduction of heat*:	0,26 W/mK
Coefficient of resistance to vapour penetration*:	22,6
Air-permeability*:	0,133 l/ im m2 Mpa
Freezing resistance*:	there is no noticeable change
Airborne sound insulation*:	30 dB at a board of 12 mm of thickness
Ph-value on surface*:	11
*informative values	

### 3.1 PSYSICAL PROPERTIES OF THE BETONWOOD® BUILDING BOARDS

#### 3.101 Dimensions of the BETONWOOD® building boards

Lenght: 3200 mm, 2800 mm  
 Width: 1250 mm  
 Usual thickness: 8, 10, 12, 14, 16, 18, 20, 24, 28, 40 mm  
 By special agreement boards with thickness other than given above can be supplied in 8-40 mm thickness range.

For sanded building boards, the tolerance compared to nominal thickness is uniformly +- 0,3 mm.

Thickness (mm)	Mass for unit surface (kg/m <sup>2</sup> ) (Density 1400 kg/m <sup>3</sup> )	Thickness margin Class I (mm)	Note
8	11,2	±1,7	
10	14,0		
12	16,8	±1,0	
14	19,6		
16	22,4	±1,2	
18	25,2		
20	28,0	±1,5	
22	30,8		Special
24	33,6		
28	39,2		
30	42,0		Special
32	44,8		Special
36	50,4		Special
40	56,0		

**Table 2.** Area and thickness with relative margin of BetonWood® building boards

### 3.102 Density of the BETONWOOD® building boards

In conformity with requirements of Standards EN634-2, Item 2 the density of boards should be more than 1000 kg/m<sup>3</sup>. According to relevant test results at a temperature of 20°C and a relative humidity of 50-60%, and at a board moisture content of 9%, the density of the BETONWOOD® building board is  $\rho = 1350 \pm 75 \text{ kg/m}^3$

For static calculations – for security reasons – it is recommended to increase or decrease the maximum value of density by 20%.

### 3.103 Moisture content in transportation

Similarly to wood in natural condition, the BETONWOOD® building board will take equilibrium moisture content according to the temperature and humidity of the atmosphere.

The moisture content in conformity with the specification of Standard MSZ EN 634-2 is

$$U = 9 \pm 3\%$$

which is reached at hygroscopic equilibrium condition corresponding to a temperature of 20°C and a relative humidity of 50-60%.

### 3.104 Equilibrium moisture content of the board corresponding to air humidity

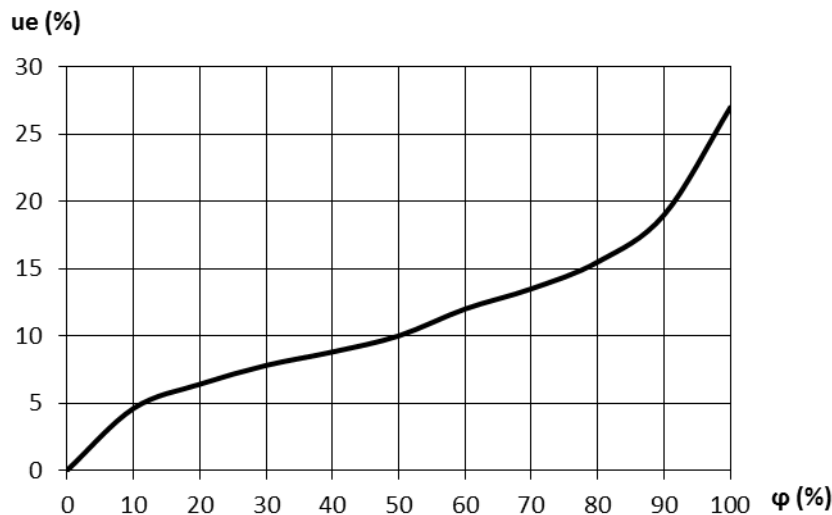

**Picture 3.**

The average equilibrium moisture content of the cement-bonded chipboard as a function of air humidity,  $t = 20^\circ\text{C}$

at a temperature of 20°C and at 35% relative humidity the equilibrium moisture content is about 7%;

at a temperature of 20°C and at 60% relative humidity the equilibrium moisture content is about 12%;

at a temperature of 20°C and at 90% relative humidity the equilibrium moisture content is about 19%.

### 3.105 Water and vapour absorption of the BETONWOOD<sup>®</sup> building boards

It is known that the moisture plays the most significant role in the destruction process of a wood chipboard. It is very important to determine the laws of water absorption and transmission as precisely as possible.

#### 3.105.1 Adsorption of the BETONWOOD<sup>®</sup> building boards

##### 3.105.11 Water vapour adsorption in atmosphere with high humidity and high temperature

$t = 40^{\circ}\text{C}$       $\xi = 100\%$  (tropical climate)

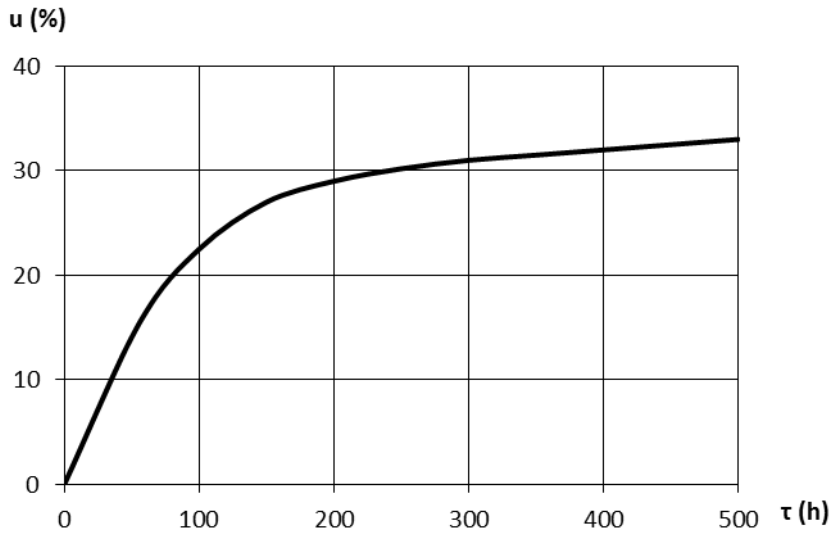

Picture 4. Water vapour adsorption ( $T = 40^{\circ}\text{C}$ ;  $\xi = 100\%$ )

##### 3.105.12 Adsorption in room atmosphere

$t = 20 \pm 2^{\circ}\text{C}$       $\xi = 45 \pm 5\%$

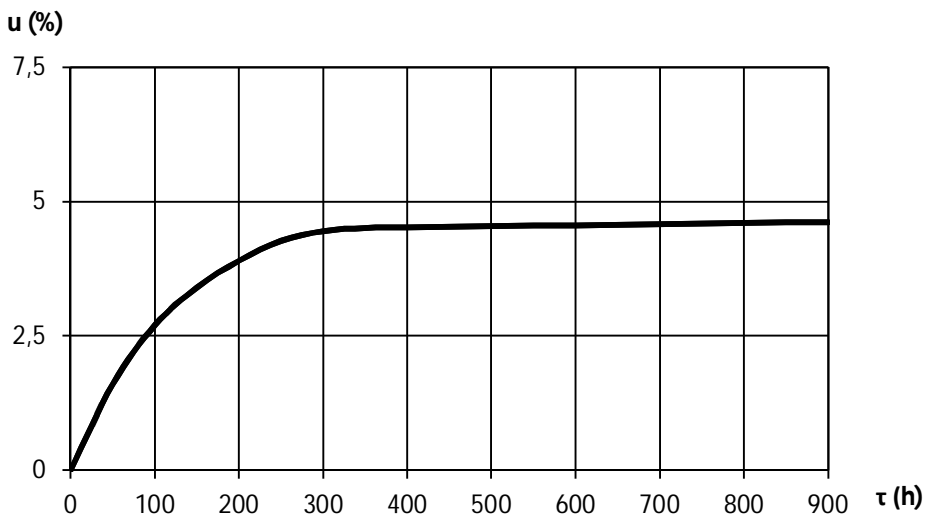

Picture 5. BetonWood<sup>®</sup> building boards adsorption in room atmosphere



We can note that the BetonWood<sup>®</sup> building boards maximum water adsorption again dry is changed. The percentage of umidity is about of 7%.

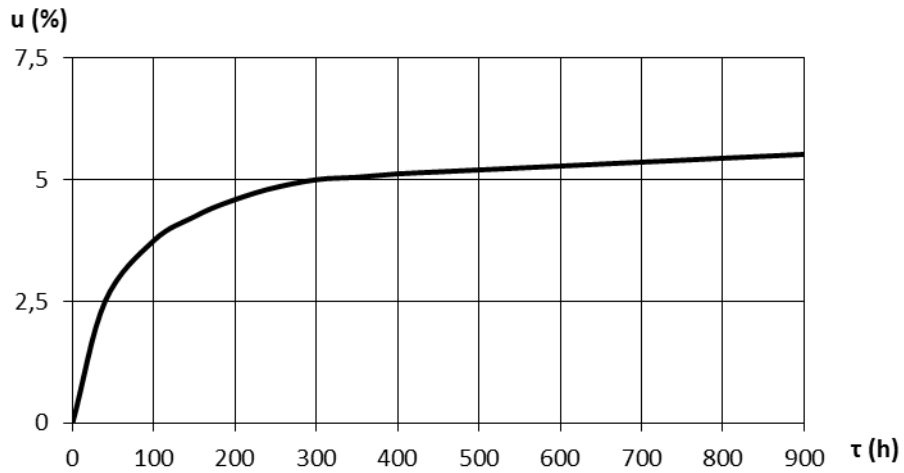

**Picture 6.** BetonWood<sup>®</sup> building boards adsorption again dry after the rain

### 3.105.2 Water adsorption exposing the board to rain

Temperature of water and atmosphere  $t = 14 \pm 0,5^{\circ}\text{C}$ , water pressure  $p = 2 \text{ bars}$

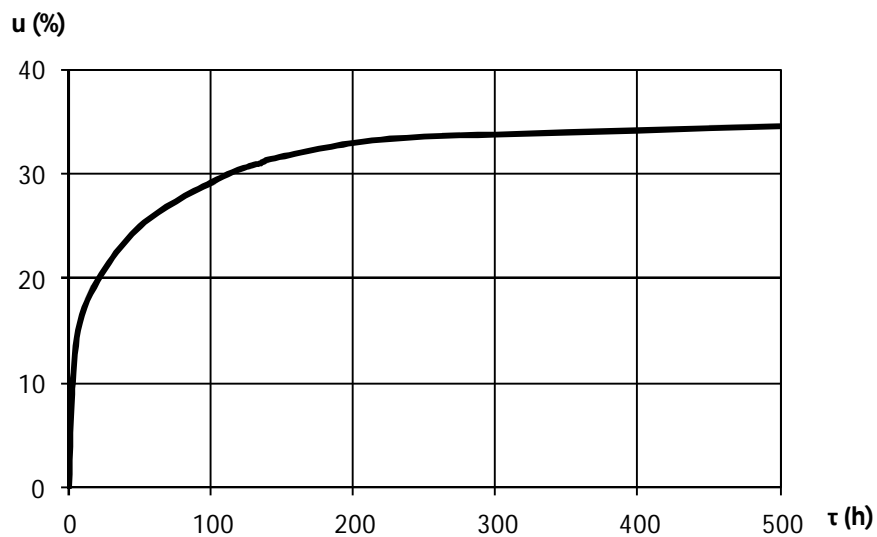

**Picture 7.** BetonWood<sup>®</sup> building boards adsorption totally dry after exposition to rain

The moisture resistance of the BETONWOOD<sup>®</sup> building board has proved to be very good.

### 3.105.3 Desorption of the BETONWOOD<sup>®</sup> building boards

#### 3.105.31 Desorption in room atmosphere

$t = 20 \pm 2^\circ\text{C}$        $\xi = 50 \pm 5\%$

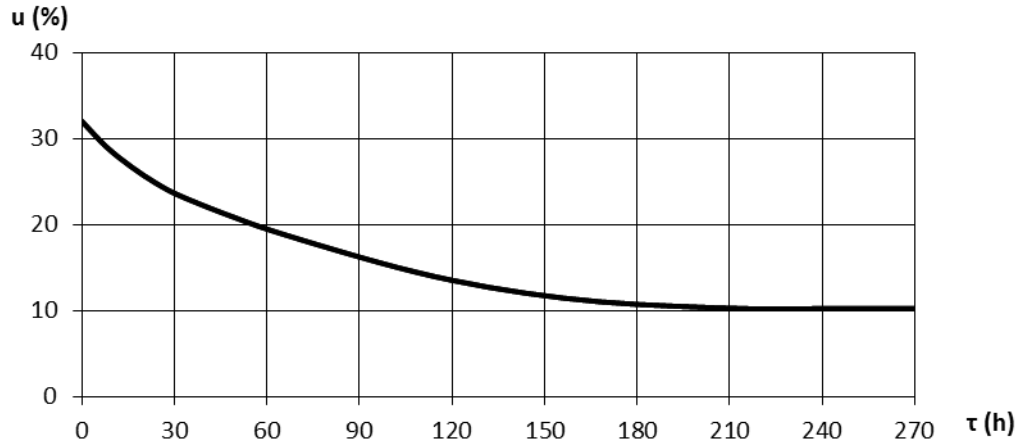

**Picture 8.** BetonWood<sup>®</sup> building boards desorption in atmosphere

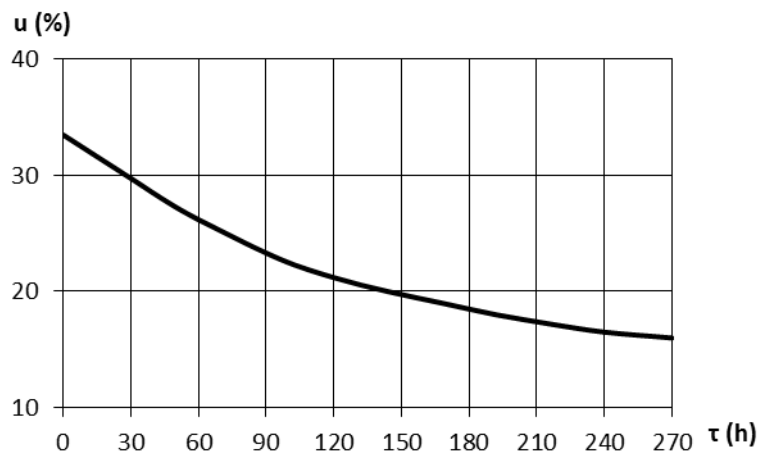

**Picture 9.** BetonWood<sup>®</sup> building boards desorption after exposition to rain

**3.105.32 Desorption of the board in equilibrium state in room atmosphere up to absolute dry state ( $t = 102^{\circ}\text{C}$ ,  $\xi = 0\%$ )**

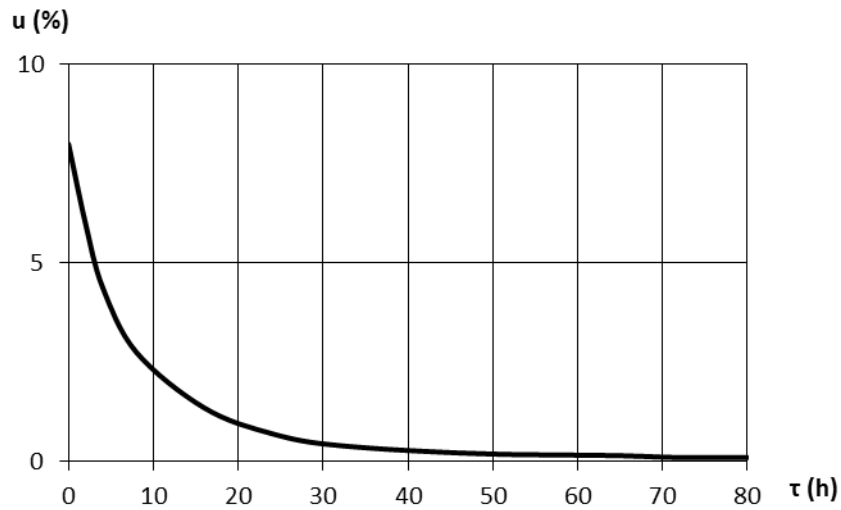

**Picture 10.** BetonWood<sup>®</sup> building boards desorption in equilibrium state in room atmosphere up to absolute dry state ( $t = 102^{\circ}\text{C}$ ,  $\xi = 0\%$ )

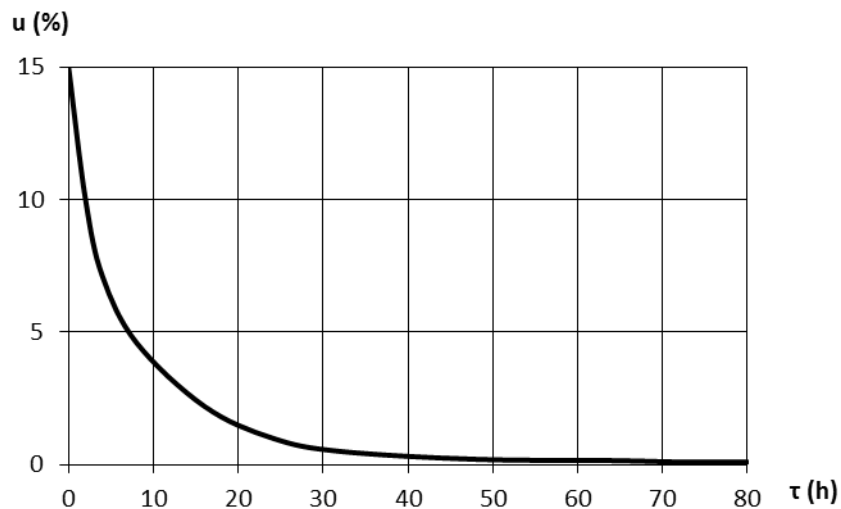

**Picture 11.** BetonWood<sup>®</sup> building boards desorption after exposition to rain and reaching the maximum temperature of ( $t = 102^{\circ}\text{C}$ ,  $\xi = 0\%$ )

**3.105.4 Conclusion**

It can be stated that the maximum water absorption of the cement-bonded chipboard is not greater than 35% even for permanent wetting. It is independent of the wetting method. Pretreatment of the board significantly influences the sorption characteristics.

### 3.106 Water absorption of the cement-bonded chipboard by soaking

The average u-max value was 27%.

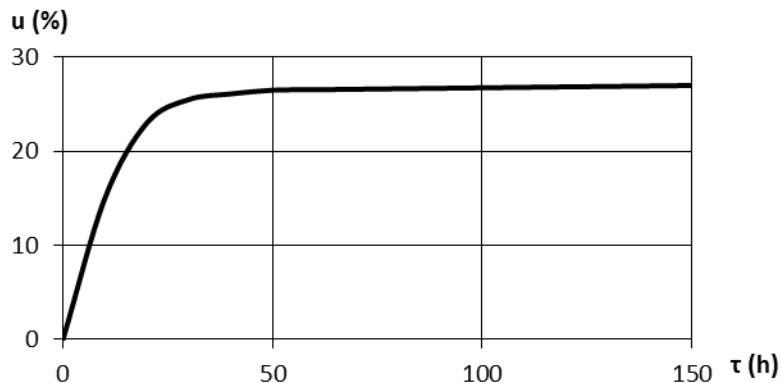

Picture 12. BetonWood® building boards water absorption by soaking.

### 3.107 Thickness swelling

When testing the cement-bonded chipboard in conformity with standards MSZ EN 317 the **thickness swelling after 24 hour soaking is 1,5%.**

### 3.108 Resistance to deformation

The two planes of the cement-bonded chipboard are usually subjected to asymmetrical climatic load. A test has been conducted under the following extreme conditions: the upper side of a test specimen freely placed in a water bath was brought in contact with air space of  $t = 20 \pm 2^\circ\text{C}$  temperature and  $\phi = 65 \pm 5\%$  relative humidity.

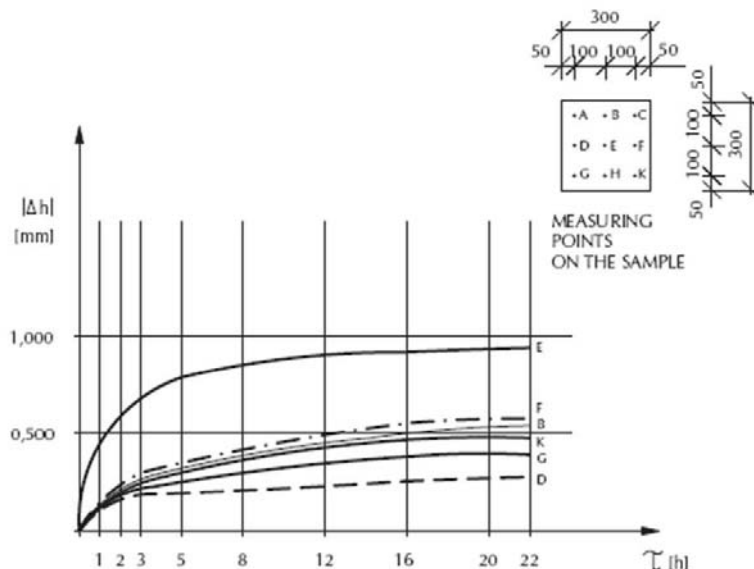

Picture 13. BetonWood® building boards resistance to deformation.

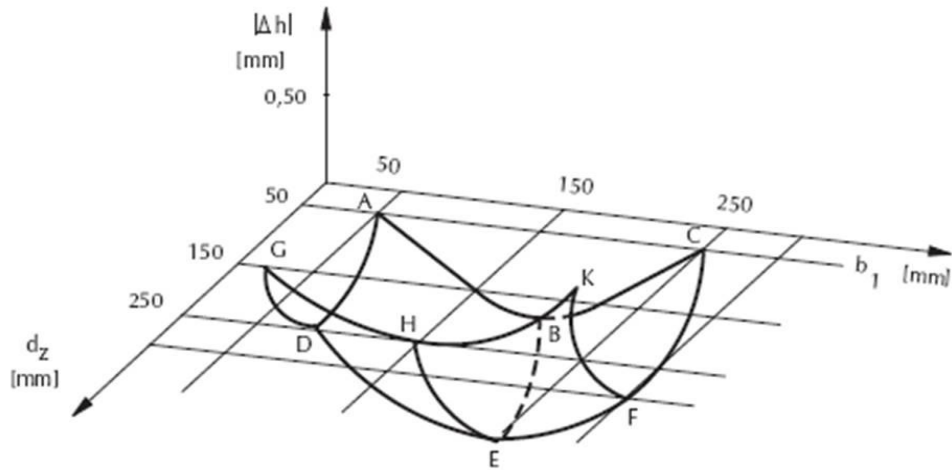

**Picture 14.** BetonWood® building boards most drastic deformation.

The most drastic deformation can be observed on the first 3 days. The highest deformation can be noted on the 22th day. In subsequent observation the deformation was insignificant.

### 3.109 Thermodynamics properties of the BETONWOOD® building board

Denomination	Symbol	Value
Density	$\delta$	$1400 \pm 100 \text{ kg/m}^3$
Specific heat	$c$	$1,88 \text{ kJ/kg K}$
Heat conductivity coefficient	$\lambda$	$0,26 \text{ W/m K}$
Resistance to air permeability	$R_a$	$4,66 \times 10^7 \text{ m}^2 \text{ sPa/kg}$
Heat linear expansion coefficient	$\alpha$	$1,0 \times 10^{-5} \text{ K}^{-1}$
Absorption water vapour coefficient	$\Delta$	$0,83 \times 10^{-11} \text{ kg/m s Pa}$

**Table 3.** BetonWood® building boards technical properties

Denomination	Symbol	Value
Density	$\delta$	$1400 \pm 100 \text{ kg/m}^3$
Specific heat	$c$	$1,88 \text{ kJ/kg K}$
Heat conductivity coefficient	$\lambda$	$0,26 \text{ W/m K}$
Absorption water vapour resistance coefficient	$\mu$	22,6
Absorption water vapour coefficient	$D$	$1,0 \times 10^{-5} \text{ K}^{-1}$
Resistance to air permeability		$0,133 \text{ l/min m}^2 \text{ MPa}$

**Table 4.** BetonWood® building boards technical properties according to standard DIN 4108

Thickness (mm)	Heat resistance
8	0,0308
10	0,0385
12	0,0461
14	0,0538
16	0,0615
18	0,0692
20	0,0769
22	0,0846
24	0,0923
28	0,1077
40	0,1538

**Table 5.** BetonWood<sup>®</sup> building boards heat resistance with different thickness

Thickness (mm)	Heat conductivity coefficient W/m <sup>2</sup> K
8	3,666
10	3,565
12	3,471
14	3,381
16	3,295
18	3,213
20	3,136
22	3,062
24	2,991
28	2,860
40	2,527

**Table 6.** BetonWood<sup>®</sup> building boards heat conductivity coefficient with different thickness

### 3.110 Fire resistance properties of the BETONWOOD<sup>®</sup> building board

The critical value of fire resistance largely depends on the composition and position of the created structure. For each newly formed structure the critical value of fire resistance shall be checked by testing in conformity with the requirements of the standard.

In respect of fire resistance of the BETONWOOD<sup>®</sup> board, the specifications of various national standards are as follows:

- Standard MSZ 595-2/1994 has to be applied.
- According to DIN 4102 the BETONWOOD<sup>®</sup> board falls into fire-resistance category "Bs1D0".

- Austrian Standard ONORM B 3800 classifies the BETONWOOD® building board as a class "A" incombustible material (Versuchs – und Forschungsanstalt der Stadt Wien, test report No. MA39-F 367/78/)

### 3.111 Airborne sound insulation of the BETONWOOD® boards

The cement-bonded chipboard in itself is not suitable for acoustical purposes. Favourable airborne sound insulation can only be achieved by proper structure design. **The sound insulation coefficient is 30 db for a 12 mm thickness BetonWood® building boards with a frequency of 4200 Berger's chart.**

Thickness (mm)	Limit frequency (Hz)	Medium sound insulation R in db
8	6300	27
10	5000	29
12	4200	30
16	3100	32
18	2800	31
20	2500	32
24	2100	33
28	1800	34

**Table 7.** BetonWood® building boards sound insulation according to different thickness

### 3.112 Surface roughness, surface quality

The quality of board surface is basically determined by the degree of roughness. Roughness is the average value of larger or smaller bulges or dents on the surface compared with a theoretical surface. For BETONWOOD® boards tested by pneumatic method, the value of surface roughness is 120-150 µm.

## 3.2 BETONWOOD® BUILDING BOARD MECHANICAL PROPERTIES

Denomination	Standard	Unit	Specific value (fo)
Density	MSZ EN 319	Kg/m <sup>3</sup>	1000
Flexion resistance	MSZ EN 310	N/mm <sup>2</sup>	9
Flexion elasticity	MSZ EN 310	N/mm <sup>2</sup>	Clase I: 4500 Clase II: 4500
Cutting resistance	MSZ EN 319	N/mm <sup>2</sup>	0,5
Thickness deformation after 24 hour	MSZ EN 317	%	1,5
Cutting resistance after cyclical test	MSZ EN 319 MSZ EN 321	N/mm <sup>2</sup>	0,3
Thickness deformation after cyclical test	MSZ EN 319 MSZ EN 321	%	1,5

**Table 8.** BetonWood® building boards technical properties according to european standard

### 3.2.1 General strenght properties of the BETONWOO® D building boards

As a guide to the design of building structures to limit stress, the specifications of MSZ 15025/1989 should be applied.

When designing building structures, the following permitted stress should be taken into account on the basis of data supplied by "Institut fur Bautechnik, Berlin"

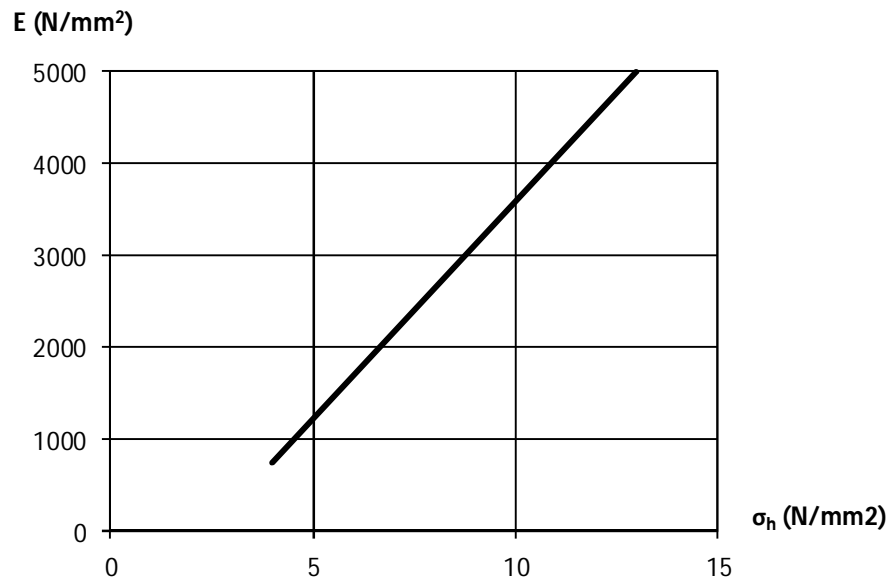

**Picture 15.** BetonWood® building strength properties

- Permitted bending strenght for loading perpendicular to plane of board:  $1,8 \text{ N/mm}^2$
- Permitted tensile strenght in plane of board:  $0,8 \text{ N/mm}^2$
- Permitted compression strenght in plane of board:  $2,5 \text{ N/mm}^2$
- Modulus of elasticity in bending for calculation purposes:  $2000 \text{ N/mm}^2$

Approximately linear correlation exists between the bending strenght and the modulus of elasticity in bending for BETONWOOD® building boards.



### 3.2.11 Buckling strenght of the BETONWOOD® building boards

Specimens of uniform cross-section, but different length were used for tests.

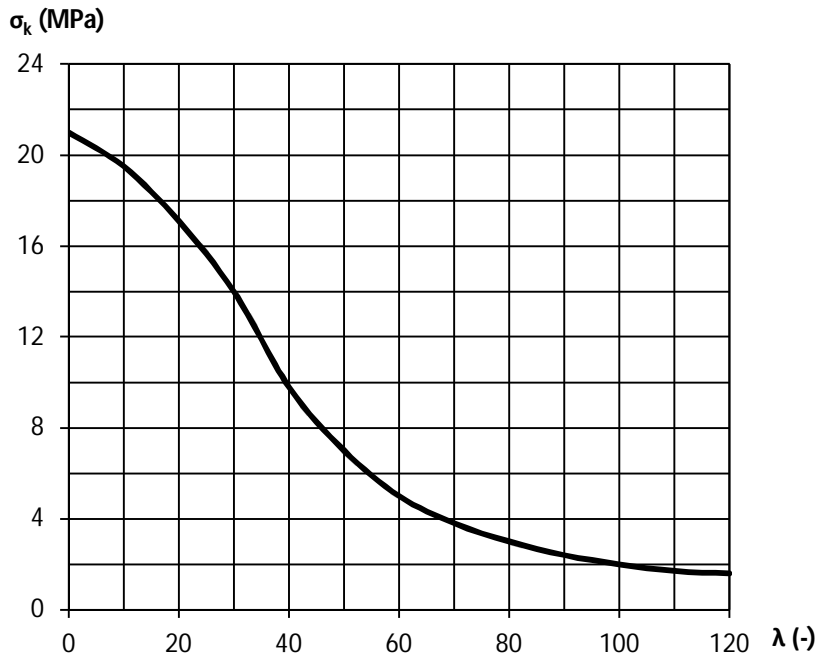

**Picture 16.** BetonWood® building boards buckling

In the case of BETONWOOD® boards, buckling applies usually to large boards rather than rods. The buckling strenght of board can be determined by quite simple calculation with sufficient accuracy.

### 3.2.12 Behaviour of the cement-bonded chipboards under the influence of thermal load

As an excellently suitable means for characterizing structural materials, the thermomechanical curve can be obtained by plotting deformation as a function of temperature.

The tests indicate that:

- The thermomechanical curve can be regarded as linear up to 120°C temperature;
- The straight section corresponding to higher nominal stress is steeper due to the more significant effect of temperature on the nonlinear part of deflection diagram;
- For higher nominal stress, from 100°C temperature, an increasing number of test specimens did not pass the load test, at a temperature of 140°C all specimens failed under load;
- From 120°C temperature – for both stress levels- a sudden increase in specific deformation occurs. It follows that **the upper limit of thermal load for BETONWOOD® boards is 120°C.**

### 3.2.13 The effect of moisture content on strenght values

The various strenght values of cement-bonded chipboard are interrelated with the moisture content prevailing at a given time.

It can be stated that the compression strength and bending strength decrease considerably due to an increase in moisture content. The tensile, shear and impact-breaking strength slightly change under the influence of moisture content. The impact-breaking strength, unlike other strength properties, improves slightly due to an increase in moisture content. Obviously, it results from the fact that the hollows are filled up with incompressible water to an increasing degree.

### 3.214 Creep of BETONWOOD® building board due to bending stress

For load-bearing structures designed for longer life, the change of individual properties in time plays a significant role. As a result of the macromolecular composition of wood, certain mechanical properties undergo changes even if load and physical properties remain unchanged which should be considered, when designing building structures. The science of rheology deals with the stresses and deformations caused by loading as a function of time.

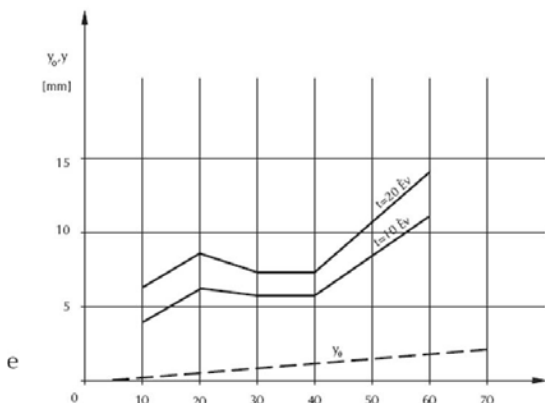
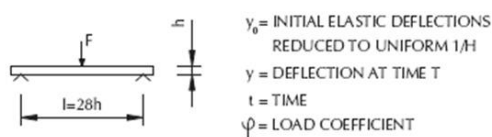

**Picture 17.** BetonWood® building boards flexion change according to time and load

The test has proved that the initial elastic deformations are much more favourable for the cement-bonded chipboards than for the traditional chipboards. It is mainly due to the higher flexural rigidity. The initial elastic deflection for the BETONWOOD® building boards is only about 1/5 of the values obtained for furniture-grade chipboards.

The degree of creep can be characterized clearly by the multiplication factor  $a$ , which depends on the load time and when multiplied by  $Y_0$  yields the actual deformation corresponding to load time  $t$ . Although the values  $a$  for cement-bonded chipboards are usually 2-4 times higher than those obtained for standard chipboards, if the load time exceeds 1 year, the actual deformations will be significantly lower.

The creep of cement-bonded chipboards consists of three main phases:

Phase I: In this initial phase the deformation occurs at the highest rate and lasts for 3-5 days /100 hours at average/.

Phase II: The rate of deformation becomes constant, the deformations show linear increase as a function of time and last for 5-30 days.

Phase III: The creep will practically stop or slow down to a degree that is negligible.

### 3.215 Balance condition for BetonWood® building boards loading

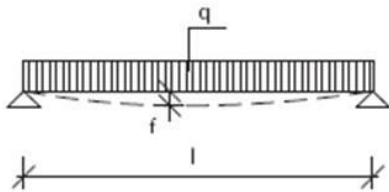

$q$  = UNIFORMLY DISTRIBUTED LOAD ( $\text{kN/m}^2$ )

$l$  = SPAN (cm)

$f$  = DEFLECTION (mm)

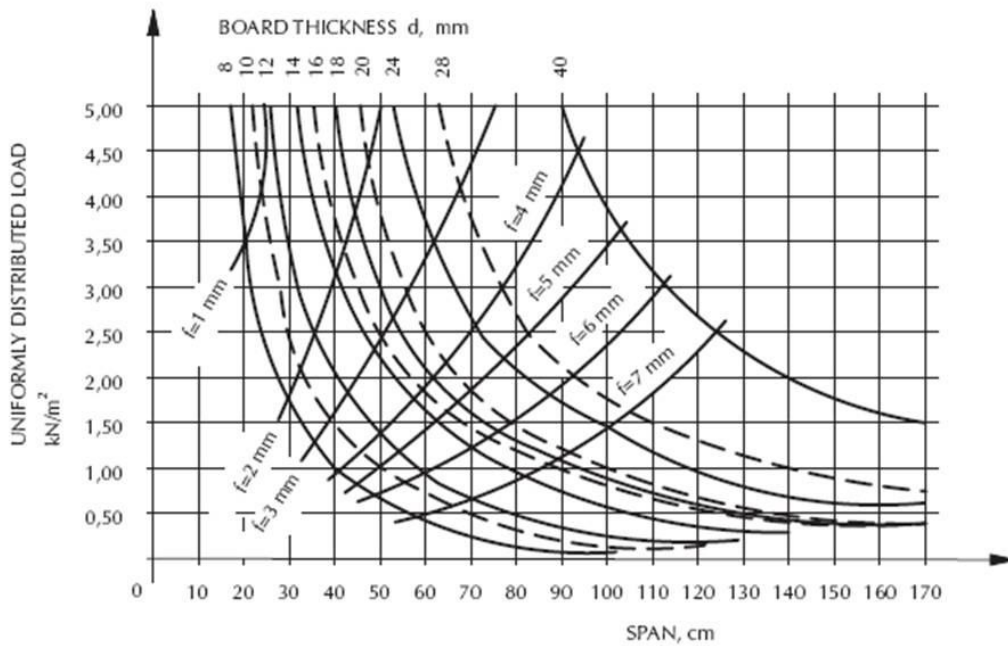

Picture 18 and 19. Relation between thickness, width, distribution load and curvature

BOARD THICKNESS (mm)	LOAD (kN/m <sup>2</sup> )							
	1,00	1,50	2,00	2,50	3,00	4,00	5,00	6,00
	SPACE SUPPORTED(cm)							
8	36	30	26	24	22	19	17	16
10	45	37	33	29	27	24	21	20
12	55	46	40	36	33	29	26	24
14	63	52	46	41	38	33	30	27
16	72	60	53	48	44	38	34	31
18	80	67	59	53	49	43	39	35
20	88	74	65	59	54	48	43	39
24	103	88	78	70	65	57	51	47
28	118	101	89	81	75	66	59	51
40	178	148	130	117	108	95	85	79

**Table 9.** BetonWood<sup>®</sup> building boards necessary width according to thickness and laod

### 3.216 Screwholding of the cement-bonded chipboards

Screwholding is considerably effected by the design of screw used for test.  
Degree of preboring: 0,8 dcs

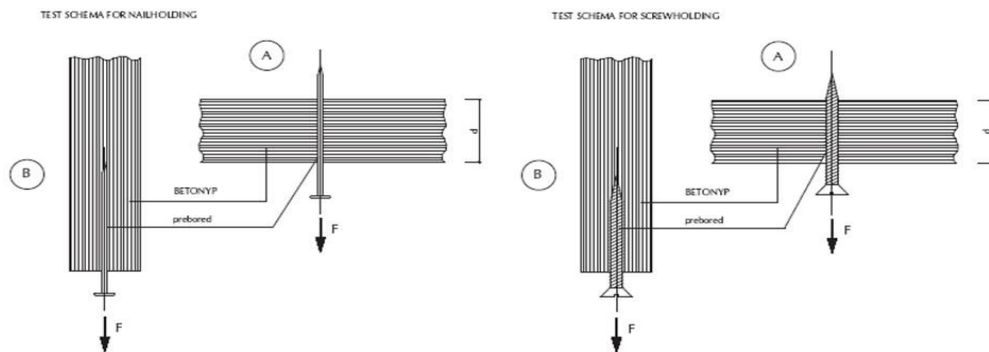

**Picture 20.** Nail and screw fixing

BOARD THICKNESS (mm)	12	18	24
TEST METHOD	NAILHOLDING (N/mm)		
A (PERPENDICULAR TO PLANE OF BOARD)	39,2	51,9	81,4
B (PARALLEL TO PLANE OF BOARD)	12,7	36,3	23,5

**Table 10.** BetonWood<sup>®</sup> building boards nail fixing value

THICKNESS OF BOARD (mm)	12	18	24
TEST METHOD	SCREWHOLDING (N/mm)		
A (PERPENDICULAR TO PLANE OF BOARD)	96,1	136,3	158,9
B (PARALLEL TO PLANE OF BOARD)	49	75,5	90,2

**Table 11.** Results of test conducted usign screw of 40 X 4 mm size in conformity with the requirements of DIN 96.

### **3.217 Fungus and insect resistance of the BETONWOOD® building boards**

The test of cement-bonded chipboards for their fungus resistance were conducted in 1976 by the Department of Forest Protection Methods in the University for Forestry and Wood Industry.

The tests of baords for their mould resistance have been carried out in conformity with the specifications of Standard MSZ 8888/9-69. The tests have proved that the BETONWOOD® building boards are "fungicides".

The tests for resistance against wood rotting fungi has been conducted in conformity with the specifications of Standard MEMSZ 50 373. The cultures of Coniophora cerebella, Poria vaporaria and Trametes versicolor, that is, fungi most damaging to building structures, have been used in the trials: None of the fungus species damaged the BETONWOOD® building boards, thus, it has been proved that the cement-bonded chipboard is "fungus resistant". This finding has been confirmed by the test report made by Mutsui Lumber Company, Tokyo.

It has been proved by tests carried out at various European institutes that the termites do not attack the BETONWOOD® building board even in the starvation phase. \BAM, Bundesanstalt fur Materialprufung, Berlin, test report No. 5.1, \4403,1985\.

The insect resistance of BETONWOOD® building boards has been confirmed also by the test conducted at the University of Tokyo, Faculty of Agriculture.

### **3.218 Weather resistance of the BETONWOOD® building boards**

The cement-bonded chipboards are weather resistant, since the wood chip particles are protected by the set cement against external damaging effects.

The material of formworks completely or partially dug in the earth did not show damage during test carried out for many years. The headquarters of the BETONWOOD® was built with socle partly made of lost cement-bonded chipboard shuttering. The nearly twenty-year-old structures have not undergone any changes. The test series conducted in this subject by the Woodworking Research Institute also confirmed these results. The cement-bonded chipbaord has been tested by EMPA/Switzerland, 1975/ in a series of measurements consisting of 150 cycles at temperature of -20oC and +20oC and at varying moisture content. These tests qualified the board as definitely frost-resistant.

It follows that the BETONWOOD® building board without finishing will withstand weathering and extreme stresses.

Permanent stress-change in relative humidity, effects of direct rain, water and steam-cause a change in the moisture content of the board. /see 3.105 and 3.106

A change in the moisture content of the cement-bonded chipaboard causes dimensional change /see 3.107/.

Dimensional change in plane:

At a temperature of +20°C, when the relative humidity changes from 25% to 90%: max. 0,3%.

In practice:

For +-10% change in moisture content of the board: +-2mm/m

When designing structures, these dimensional changes should be taken into account.

In practice more favourable values will be obtained.

The Quality Control Institute for the Building Industry obtained the following results by testing cement-bonded chipboard in a FEUTRON device for 96 hours in an atmosphere maintained at 60°C temperature and at 100% relative humidity.

Thickness swelling	0,92%
Dimensional change in plane	0,15

(Test report of EMI Nr. M-34/1975)

#### 4. Machining, fixing, jointing, bonding and finishing of the BETONWOOD® building boards

##### 4.1 MACHINING OF BETONWOOD® BUILDING BOARDS

###### 4.11 Basic principles of machining

Machining of BETONWOOD® building board requires the use of carbide tipped tools. Traditional (iron, chrome-vanadium) hand-held tools can also be used for machining, however, the tool wear will increase in this case.

The use of metallurgical tools-metal saws, metal borers-also facilitates manual processing. It is recommended to provide for dust exhaustion of appropriate efficiency, when machining BETONWOOD® building boards.

The min. exhaustion speed should be 30 m/s.

###### 4.12 Recommendations for major operations using hand-held electric and pneumatic machines

###### 4.121 Cutting-of and cutting to size

It is recommended to use carbide tipped saws. The cutting depth shall be adjusted so that the saw blade protrudes only slightly (3-8 mm) from the BETONWOOD® building board. Favourable edge quality, improved edge durability and low cutting resistance can be obtained by the use of carbide tipped saw blades. The "A" and straight tooth types are arranged alternately. Saw blades with other shape can also be used, the edge durability edge, however, be reduced.

( $n_{min} = 4500 \text{ min}^{-1} = 75 \text{ s}^{-1}$ )

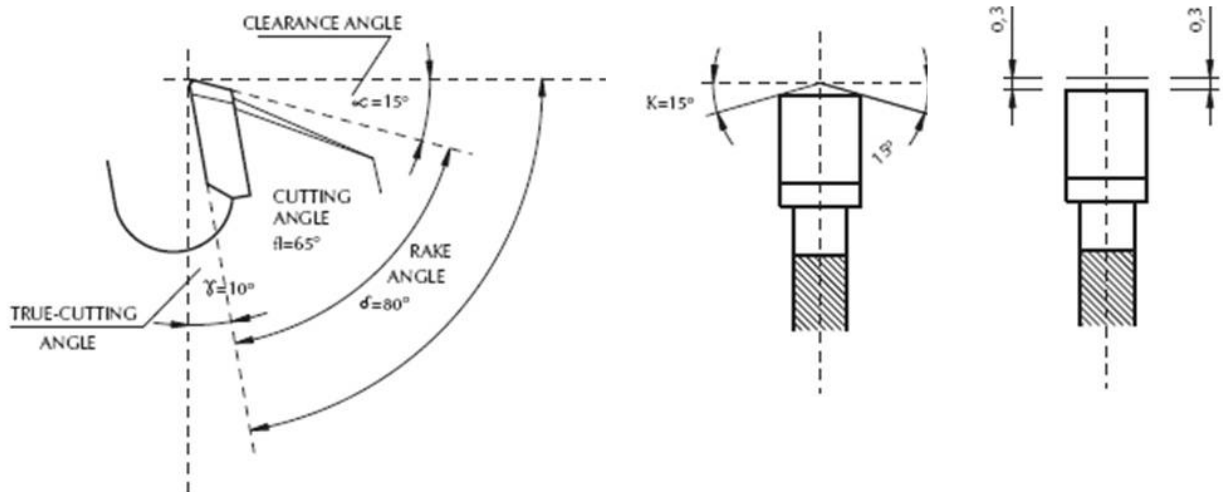

**Picture 21.** Cutting tools for wood with metallic carbide recommended for BetonWood® building boards cutting

#### 4.122 Groove cutting and mortising

It is recommended to use carbide tipped rip saws. ( $v = 1,5-6 \text{ mm}$ ).  
( $n_{\text{min}} = 5300 \text{ min}^{-1} = 88 \text{ s}^{-1}$ )

#### 4.123 Circular and other offcuts

Electric compass saw can be used for cutting holes with a diameter larger than 30 mm as well as for cutting various forms and for angular cutting.  
( $n_{\text{min}} = 1600 \text{ strokes/min}$ ).

#### 4.124 Boring

High-speed steel or in series production-carbide tipped borers are recommended to use for this operation ( $n_{\text{min}} = 400 \text{ W}$ ;  $n_{\text{min}} = 1200 \text{ Min}^{-1} = 20 \text{ s}^{-1}$ )

The higher the r.p.m. of the boring machine, the cleaner bores can be obtained. It is recommended to use hardwood counterpiece on the exit side of the borer. Feed rate should be maintained at low value.

#### Recommended type of carbide tipped borers:

- From 1,5 to 16 mm diameter: helical drill with 60° cone angle
- From 8 to 16 mm diameter: mortiser with guide tip and scoring edge
- From 16 to 40 mm diameter: hinge borers with guide tip and cutting edges

Borers with diameter from 1,5 to 16 mm can be provided with counter sinking fixtures having carbide tipped cutting edge.

#### 4.125 Milling

It is recommended to use carbide tipped cutters for this operation, too. Cutter sets with reversible blades ensure quick tool replacement and high accuracy.  
( $n_{\text{min}} = 22000 \text{ min}^{-1} = 367 \text{ s}^{-1}$ )

#### 4.126 Sanding

Unevenness in joint can be eliminated by sanding. Recommended grit size of the sanding paper: 60-80. Appropriate cutting depth can be achieved only by the use of belt sanders. Dust exhaustion should be provided under any circumstances.

( $v = 350 \text{ m/min}$ )

#### 4.127 Nailing, clamping

The mechanically prebored BETONWOOD® building boards can be nailed using manual methods. Their fixing to natural wood material can be carried out efficiently by means of mechanical nailers and pneumatic clammers with automatic feed. The wood-board joint can be improved significantly by the use of spiral nail.

#### 4.128 Screwing

In series production the BETONWOOD® building boards can be screwed to ribs using pneumatic or electric screw-driving machines. When assembling structures, screw with two-start thread can be used most efficiently.

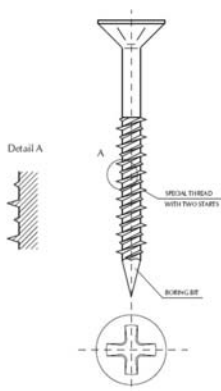

Picture 22. Screw with crossed cutting and double threads



**Picture 23.** Example of screw for BetonWood® building boards

#### 4.2 FIXING OF THE BETONWOOD® BUILDING BOARDS

The cement-bonded chipboards can be fixed by pneumatic and manual nailing, spiral nailing, screwing and pneumatic clamping.

Screwing	Nailing	Clamping	Bonding
With preboring. Bore diameter for nailing: $D=0,8-1,1 \times D_s$ $D_s$ =diameter of screw.	Without preboring for chipboards with thickness under 10mm. Above this thickness preboring of chipboards recommended. Bore diameter for nailing: $D=0,8 \times D_n$ $D_n$ =diameter of nail shank.	Recommended for chipboards with thickness under 12 mm only using clamps with legs of intermediate length and an approved clamping tool.	Provides additional joint for nailing and clamping. Use of alkaline reaction adhesives recommended.

**Table 11.** Technical properties for fixing.

When fixing the cement-bonded chipboards, they have to be placed on the frame ribs accurately.

- The fixing distances at corners are to be selected so that excessive weakening of cross-section may not occur.
- It is recommended to apply screwen fixing for boards with more than 16 mm thickness.
- It is required to use plated/corrosion resistant/fasteners and fittings/zinc-plated, cadmiated etc./
- Proper support of boards should be provided during fixing for any assembly method.



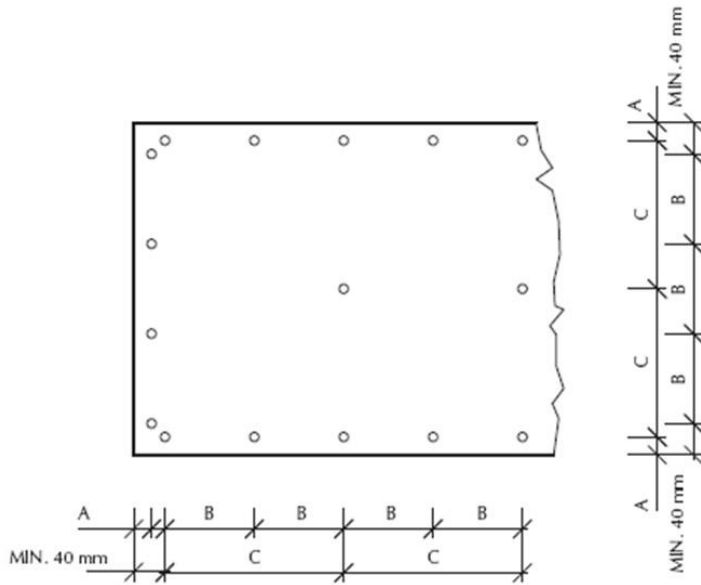

**Picture 24.** Correct distance for BetonWood® building boards fixing

### Bonding

We recommend alkaline paste like Mapelastic (Mapei brand) or Sikalastic for external use to absorb the natural dilatation. We recommend also using primer or Mapelastic with paint roller system on the BetonWood® building boards surface.

Board thickness (mm)	Fixing distance (mm)		
	on board edge A	on board edge B	on board edge C
8, 10, 12, 14	20	200	400
16, 18, 20	25	300	600
22, 24, 28	25	400	800
40	40	600	1200

**Table 12.** Distance recommended according to BetonWood® building boards thickness.

### 4.3 FORMING OF JOINTS

When designing BETONWOOD® structures, the following recommendations should be considered in connection with making extension:

- Dimensional change of the building component depending on temperature
- Dimensional changes depending on moisture content
- Movement of load bearing structure
- External effects, loads (wind pressure, vibration, etc.)
- Fasteners (type, size, quantity etc.)

When making extensions, the width of underlays should be selected properly to ensure reliable support.

### 4.31 Visible joints

A wide range of extensions can be made with BETONWOOD® boards by various edge forming.

THICKNESS UNDER 14 MM

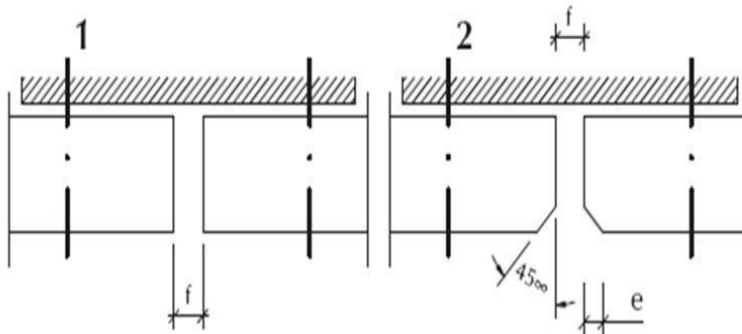

THICKNESS OVER 14 MM

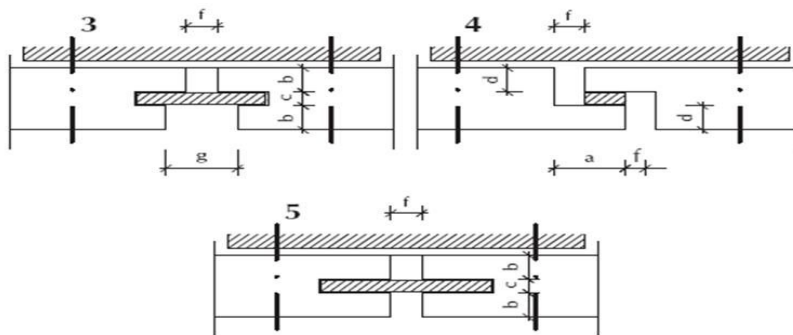

THICKNESS OVER 18 MM

Esempio di pannello BetonWood® maschio/femmina

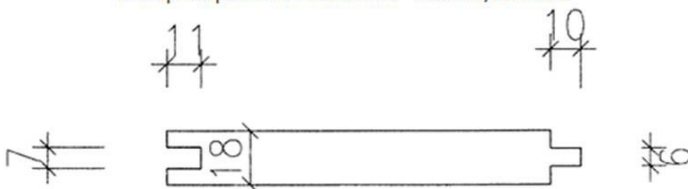

**Picture 25, 26 E 27.** BetonWood® building boards joint according to different thickness and profile

Symbol	Joint dimension according to thickness		
	under 14 mm	between 14 to 24 mm	over 24 mm
	recommended value (mm)		
a	-	11÷16	max 20
b	-	min. s/2 -2	min 8
c	-	max 4	max 8
d	-	s/2-0,5	s/2-1
e	min 3, max s/3	min 3, max 5	min 3, max s/4
f	8÷10 (according with board dimension)		
g	-	2f	2f

#### 4.4 BONDING

Before the selection and the application of an adhesive for BETONWOOD® boards it is highly recommended to ask for technical information at the supplier of the adhesive.

#### 4.5 FINISHING, PAINTING

When finishing BETONWOOD® building boards, the following properties of board should be considered:

- Due to its considerable cement content, the board shows alkaline reaction (similarly to concrete)
- The boards surface is smooth and quite high absorbent
- The moisture content of board should not exceed 14%.

Due to the alkaline of board, either alkaline resistant materials should be used for finishing BETONWOOD® boards or alkaline resistant prime coat should be applied to the boards.

Purpose of priming:

- To reduce surface alkalinity
- To make absorbance uniform
- To decrease moisture adsorption

The so called "deep primers" resistant to alkalis (that do not show saponification on the surface) can be used for this purpose.

Before the application of the finishing materials it is highly recommended to ask for technical information at their suppliers.

Repair of minor damages of the board:

Deep prime the damaged part together with the other parts of the surface, then fill the gap using DEKO putty. Once dried, align the puttied part with the sound parts of the surface by sanding.

To paint BETONWOOD® building boards it is recommended to use complete coating systems developed by various paint manufacturing companies.

#### 4.6 WALL-PAPERING

Wall-papering is a generally recommended surface finishing method for living rooms.

**Surface preparation:** Finishing of joint gaps or repair of possible surface defects by gypsum plastering (Breplasta). To compensate for the possible slight movement of structure, elastic polystyrene foam board or gypsum plasterboard is placed under the wall-paper. This sliding layer gives a surface ready for final surface forming.

- Wall papering with polystyrene underlay: The wallpaper underlay is available in panel sizes. Make sure that the vertical strips are jointless. The edge-to-edge joint should not coincide with the panel joint and should preferably be free of gap.  
First apply adhesive uniformly to the wall surface to be papered (by means of brush and distributing comb), then to the wall-paper underlay. Surfaces prepared this way should be left drying for about 10 min. A 3-4 m<sup>2</sup> area of wall surface is recommended to be papered simultaneously.  
The wall-paper underlay can be applied to the wall surface by means of TEDDY roller so that the air enclosed between layers is squeezed out, when moving the roller in one direction.

- Wall-papering with gypsum plasterboard: The gypsum plasterboard is available in panel form, which should be cut to size accurately prior to placing. The panel is to be fixed by screwing, starting at the centre and proceeding downwards. The panel should be fixed on its periphery and centre line alike to the panel ribs, making sure that the juncture of panel joint and gypsum plasterboard is in offset position. Full threaded chipboard screw of min. 35 mm length is to be used. The fixing distance is max. 200 mm and min. 15 mm from the board edge. The gap formed between screwed-on panels should be filled with gap-filling gypsum. The location of screw-heads is to be masked by gypsum plastering.

The wall-papering technology used for surfaces prepared this way is similar to that applied for traditional wall surfaces.

For light wall-papers with overlapped joint, the wall-paper can be applied directly to the foam board without surface justifying. Special wall-papers and claddings can be bonded with water-based dispersion adhesive. Particular care should be taken, when wall-papering vertical wall corners. Do not take over the wall-papers continuously to the neighbouring wall surfaces. Here the wall-papers should be jointed by leaving slight overlaps and bonding only one of the overlapping layers.

It is recommended to perform wall-papering prior to locating the cover fillets and skirting boards, because it facilitates jointing of wall-paper borders at the horizontal edges and at the skirtings of doors and windows.

**Important:** The adhesive, putty, paint used for PS foam board may not contain organic solvent.

#### **4.7 CLADDINGS FOR "ROOMS EXPOSED TO WET CONDITIONS"**

##### **4.7.1 PVC cladding systems**

The cladding systems are suitable for making jointless, high resiliant claddings in "rooms exposed to wet conditions"/toilet, bathroom, lavatory/ and on wall surfaces above kitchen worktop.

- Preparation of surface:  
The unevenness of socle and floor slab under the flooring board should be eliminated. The following socle finishing materials can be used for ground-floor rooms: polymer mortar, self-spreading floor mass.
- The surface defects in panels under the wall-cladding material can be repaired with DEKO putty.
- First the floor covering should be prepared. The flooring material laid free of gap should be welded together at the joints. Water-tight, trough-like layer should be formed by felding the floor covering to the vertical wall surfaces in min. 10 cm height. Special care should be taken, when welding the corners.
- The wall cladding should be bonded free of gap by cutting it so that the wall cladding material 5 cm overlaps the folded edges of the floor covering formed in a trough-like

fashion. Thus it can be ensured that no utility water enters the panel structure of the building. Bonding of PVC coverings is recommended to be performed by specialist.

#### **4.72 Tiling**

Tiles form a stiff layer on the wall surface (or on the floor), therefore, the following instructions should be observed, when covering with tiles:

It is recommended to design an extraordinary solid load-bearing structure (solid frame building, regular fixing of boards). The movement of load-bearing structure might cause splitting or even breaking of tiles.

- The tiles should be applied in a netted structure, leaving min. 3 mm gap between tiles. Similarly, when forming corners, min. 3 mm gap is required.
- At corners joints, only permanently elastic material is permitted to be used for filling the gaps (Silicon or Acrylpaste). It is important to take into consideration that silicon type filling materials can not be coloured or painted afterwards. Therefore using silicon filling material, coloured type should be applied. Acryl pastes can be painted afterwards.
- Specially at bigger wall facing an elastic material has to be placed between the BETONWOOD boards and tiles in order that to form a sliding layer. This layer can be a polystyrene foam board to instructions (PS board by bonding, gypsum board by screwing).

Tiling can be made on this surfaces. When bonding the tiles on, the adhesive supplier's instructions must be followed.

- If the flooring of the room exposed to wet conditions in the roof space is also made of ceramics – especially if BETONWOOD floor is placed between the ground-floor and the loft - , reliable water proofing should be provided.

This insulation can be renderset (BITUGEL) and bonded (bitumen + bituminous boards).

The insulation should be made by folding it to the side walls by min. 10 cm.

BITUGEL should be used to bond the ceramic covering to the insulation prepared this way.

At the corners elastic material should be used for filling the gaps.

#### **5. Basic principles of the BETONWOOD structures**

The previous chapters gave an introduction to the application, the physical properties, and the main features of the BETONWOOD® building boards. Obviously the BETONWOOD® building boards can be used in several area of the building industry.

BETONWOOD® S.r.l. and its predecessors also used to produce plane boards, differently processed board products, and to manufacture and distribute products, constructions and elements for so called complete loading systems. For now this later activity has been ceased on the one hand because of an intention for clearing the company's profile and on the other hand because of the complicated constructions of boarding systems and the complexity of customer response and serving the client's demands on a standard of our days.

Our intention was that the development, design, manufacturing, and distribution of constructions can be formed by using BETONWOOD® building boards are to be accomplished by professional contractors specialised on this kind of activities providing our customers with the highest competence and expertise.

In spite of these events, during those years which were dedicated to introduce the BETONWOOD® building boards into the market and to get them accepted by both the domestic and foreign customers in building industry, BETONWOOD® S.r.l. and its predecessors have gained significant experience and expertise in connection with the application of the building boards. Therefore now we can publish some basic feature and possible purposes for the application of the product in order that our clients can derive benefit from them during the application of our board products.

### **Important!**

It is essential that BETONWOOD® building board is a basic commodity produced for the building industry similarly to the brick or cement. Therefore it is very important to accentuate again that any product or construction applying BETONWOOD® building boards has to be designed taking customer requirements into account previously.

During the design process the physical, mechanical, fire resistance and airborne sound insulation properties of building boards must be taken into consideration.

### **5.1 SHUTTERING**

The BETONWOOD® building boards are adaptable to prepare several kinds of form-works or to make a complete shuttering system creating a full scale of sizes and types of boards.

Re-applicable as well as built-in form-works can be created.

In both cases any configuration, building wing or plane intended to be created by shuttering will be prepared for further uncomplicated surface formation methods.

Shuttering types can be formed with BETONWOOD® building boards:

- Dry form-works for socle and lost-in shuttering called shuttering block as well
- Prefabricated lost-in shuttering mounted with reinforced concrete sometimes with heat insulation for walls of cellar or other buildings
- Roof form-works

For the architecture to the built-up BETONWOOD® building boards with appropriate thickness and size should be selected in order that to meet the static requirements and regulations for the construction.

When using re-applicable dry form-works, a special anti-binding additive must be applied so as to avoid the formation of a permanent joint between the form-works and the construction body. In case of lost-in form-works to create perfectly gap-free surfaces, formation of a secondary casing is recommended with gypsum or gypsum-fibre boards.

### **5.2 EXTERNAL CLADDINGS**

Using finished or unfinished BETONWOOD® building boards a frame-based cladding technics with built-up elements can be created which is suitable to the simultaneous cladding and insulation of facades.

#### **Applicable to create**

*External cladding of facades such as:*

- Aesthetical cladding,
- Cladding combined with supplementary insulation,
- Additional protection against rainfalls.

*Supplementary elements for external claddings such as:*

- Decoration,
- Baluster element of balconies or loggias,
- Shading element,
- Cladding for sunblinds.

*External wall constructions such as:*

- External jacket for light-weight panels,
- Mounting board for loggias,
- Closing board for tunnel shuttering technics.

The main advantages of a correct and reasonable cladding system over a rendering type are as follow:

*Regarding the physical properties of constructions:*

- Ventilated construction with doubled jacket,
- No problems with vapour diffusion,

- Provides shading in summer and heat insulation in winter.

*Regarding the implementation aspects:*

- Removal of former cladding is unnecessary,
- Requires dry technics for implementation,
- Implementation is independent of seasons or weather.

*Regarding the aspects of maintenance:*

- The general maintenance required in a cycle of 10 years for traditional plasters can be eliminated.  
Only worn colour must be refreshed.
- The external cladding has the same durability than the base construction has.

*Using BETONWOOD building boards the following cladding systems can be created:*

- Cladding systems with big elements,
- Cladding systems with intermediate elements,
- Cladding systems with small elements.

*The ways of fixing can be:*

- Visible or invisible.

*Setting of covering elements can be:*

- Accentual or unaccentual and overlapped in a scaly way.

When using the BETONWOOD building boards for cladding, instructions for the base material should be taken into consideration.

### **5.3 INTERNAL CLADDINGS**

The cement grey coloured BETONWOOD® building boards can be used for creating several kind of internal claddings which are designed, machined to dimensions, and finished according to the requirements of the final utilization.

*Applicable as room divider in:*

- Public institutions
- sports buildings
- industrial and communal infrastructures
- social institutions as an aesthetical and fire protective cladding, thermal insulation, airborne sound insulation, and protection against vapour diffusion.

Applicable as supplementary element for interior decoration like:

- side-rails for staircase, aesthetical accessories
- aesthetical covering for pipe fittings and cables
- sounding-boards

### **5.4 FLOOR COVERINGS, STILTED FLOORS FOR COMPUTER ROOMS**

Mechanical properties of BETONWOOD® building boards offers a wide range of utilization, such as replacement of concrete base layers or information of stilted floors for computer rooms.

A new product the BETONWOOD® PLUS fibre-forced building board can offer many new possibilities for application. One side of this board is reinforced with a fibreglass-polyester net of high tensile strenght. When bending stress occurs this fibre net situated in the section of tensile load.

Therefore tensile strenght of the building board is significantly increased.

To cover floors or replace concrete base layers boards of standard sizes can be applied or prefabricated and custom-made boards can be prepared with a supplementary insulating layer of several types of materials and thickness.

*Finished floor elements can be applied for:*

- panel,
- moulded or light-weight building methods.

**Applicable in:**

- family dwelling-houses, living rooms
- public institutions, rooms with warm floor
- office buildings, office rooms

*Advantages of application for floor coverings are as follow:*

- the weight of construction can be minimized,
- fast implementation, excellent sound and heat insulation properties,
- provides an ideal under-plate for parquet floors, PVC floors, and broadloom carpets,
- offers a building method not requiring additional water content to avoid the unintended damage of existing constructions.

Floor coverings made of BETONWOOD® building boards should be designed to meet the requirements of the final utilization of the construction and mechanical properties of building boards should be taken into account.

Physical and mechanical properties of BETONWOOD® building boards allow their utilization as a covering material for assembly tunnels hidden above suspended ceilings or under stilted floors of computer rooms.

In case of utilization for the above-mentioned applications the following aspects should be taken into account:

- Thickness tolerance of the BETONWOOD® building boards can reach +- 1,0 mm. Therefore application of products prepared with justified sanding is offered.
- Thickness and dimension scale of the required elements determined by the supporting frame system.
- Further mechanical properties recommended to be taken into account are:
  - general strenght properties,
  - creep of building boards due to bending stress,
  - equilibrium conditions for loading of boards.

The BETONWOOD boards meet the former requirements and possess the needed dimension scale can be finished and cladded according to the customer's requirements with material appropriate to create anti-static walking surface.

## **5.5 ELEMENTS FOR SUSPENDED CEILINGS**

After proper design of the construction the BETONWOOD® building boards can be offered as a cladding material for suspended ceiling systems.

*Using suspending elements the following applications can be made:*

- unaccentual suspended ceiling with hidden fixing points
- accentual or jointed suspended ceiling with visible fixing frame

The field of application can be wide because of the properties of system elements and of the construction. Applicable for intermediary and roof ceilings of any building to create plane and horizontal suspended ceilings with the following functions:

- fire protection,
- decoration,
- heat insulation,
- airborne sound insulation.



*Occasionally the functions of application are multiple:*

- fire protection with the insulation of airborne sound,
- insulation of airborne sound and decoration.

The building construction should be designed according to the mixed requirements and mechanical properties of either the other components and of the BETONWOOD® building boards as a main component should be taken into consideration.

## **5.6 SELF-SUSTAINING WALL AND PANEL CONSTRUCTIONS**

In the building industry the application of light-weight constructions spreads widely, and gets gradually accepted, even more in certain areas their application is essentially required besides the traditional solutions. The possibility of a fast implementation and the relatively low expenses are the main reasons for this tendency.

A small segment of the application and utilization possibilities of the BETONWOOD® building boards has been introduced by the previously mentioned solutions. In light-weight architecture this product has a significant role during the creation of the different kinds and types of wall constructions and building board systems.

*Regarding the function of the wall construction the following applications are offered:*

- external and internal load-bearing walls, wall-panels,
- dividers, wall-panels,
- frame filling wall-panels,
- roof and ceiling constructions, panel constructions,
- other supplementary constructions and panels.

*Regarding the construction the following types can be created:*

- small panel constructions,
- intermediate and large panel constructions,
- constructions mounted on a frame,
- frame-constructions mounted on the spot.

*The BETONWOOD® building boards can be mounted on the following frame types:*

- wooden-frame constructions,
- metal-frame constructions,
- the frame construction itself made of BETONWOOD® building boards, too.

The above-mentioned constructional solutions can be applied to construct several kinds of buildings on a wide range from communal institutions and industrial facilities through sheds and hangars to dwelling houses.

Prior to the building process these constructions should be designed according to and in compliance with the requirements proceeded from the final utilization of the building. During the design procedure all instructions referring to the application of BETONWOOD® building boards should be strictly observed.

It is important to study what kind of other materials will be applied during the construction and whether the contractor staff will have the required skill and expertise to work with these materials.

Mechanical properties and main features of both the BETONWOOD® building boards and the other base materials should be taken into consideration in order that constructions can be developed in a functionally and technologically correct way. Therefore the expedient design procedure of the construction has a special importance.

Building constructions may have so called secondary functions as well which depends on the environment they are intended to be built in or on architectural and regional regulations must be complied.

*Regarding the secondary functions the construction can be an additional:*

- heat insulation,

- fire protection,
- sound insulation.

In accordance with experience of several years it can be stated that architects familiar with mechanical properties of BETONWOOD® building boards have designed and built several constructions meeting all those requirements – even special ones too – which are to be taken into consideration.

Some special physical properties which can be provided with the application of BETONWOOD® building boards:

1. Accounting on thermal properties energy saving constructions can be designed according to requirements of our days.

Constructions with excellent coefficients of thermal conductivity and heat transmission can be designed.

2. Good critical values of fire resistance can be reached with expedient board constructions.
3. Regarding the high density value of BETONWOOD® building boards they can be used for acoustical applications too, but principally in constructional forms.

Design of special constructions has to be inspected by assigned authorities in any case.

## **6. Additional information on constructions made of BETONWOOD® building boards**

When building a construction applying BETONWOOD® building boards, some of the final skilled works has to be accomplished in a different way than it is usually made and a special care is required.

In the following chapters some of these skilled works requiring special expertise and care will be introduced.

### **6.1 BRICKLAYING OF CHIMNEYS**

In the roof a hole for the chimney-shaft must be prepared during the construction of the building. The roof structure must be evolved not to contain any break through the load-bearing beams, and this rule has to be taken into consideration during the design and the implementation process.

**At the brickwork of a chimney it is an important instruction that the chimney-shaft must be placed at least 10 cm far from the wall-boards. The chimney-hole in the roof and the wall-board around the chimney-shaft must be covered by asbestos boards.**

When placing a stove or a fireplace by the well-boards, a similar procedure of construction must be followed.

Any heating device is recommended to be built in the same room the chimney-shaft, on the contrary the smoke outlet has to be led to it through the light-weight structure of the wall.

### **6.2 ELECTRICAL INSTALLATIONS**

In a building structure the horizontal and vertical electrical cables must be led in standard plastic wall-tubes of a diameter of 23 or 16 mm.

Preparation of holes for sockets and fittings:

Socket holes can be prepared using a special borer with a diameter of 68 mm designed expediently for sinking socket holes. The applicable sockets – type UGD 60 is recommended – should be placed into these holes.

The plastic sockets with 60 mm of diameter and also 60 of depth can be mounted from only on side of the wall in order that aesthetical fittings can be applied. The fastener tongues of UGD 60 flush-mounted socket provide firm fixing to boards with 8-30 mm of thickness.

Any building structure can be selected by the customer, but it is very important that electrical installations must be accomplished with a special care and expertise.

During the setting of spot, halogen or other type of lights can be flushed into the roof or ceiling, the instructions of the manufacturer should be applied with special attention to technical conditions that can occur at these constructions.

### **6.3 BUILDING CONSTRUCTIONAL WOKS**

#### **6.301 Hot and cold water supply**

In constructions made of BETONWOOD building boards a plastic conduit-pipe system can be applicable for providing both hot and cold water supply.

Its main advantage over steel pipes is that the flexibility of plastic pipes ensures that they can be flush-mounted into the light-weight wall construction without crossing any vertical frame-rib.

Since fittings can be found at the ends of the pipes the plastic water pipe can be led in an intubation tube with a diameter of 23 mm in any place.

Installation holes for flush-mounted pipes and fittings can be prepared using carbide tipped disk saws with cutting depth adjusted to 12 mm or other cutting tools can be used such as compass-saw or socket-plate borer used at electrical installations.

Leading pipes through the roof or a wall-board, a metal or PVC sleeve must be placed into the hole as a liner.

Set up on the wall:

Equipment with weight above 5 kg (basin, WC, flush-box) can be firmed on the wall by using a steel plate with a thickness of 2,5 mm which must be mounted direct to the wall-board.

The plate size and the fixing position on the wall should be defined in order that the plate can be connected to two frame-beam at least.

#### **6.02 INSTALLATION OF HEATING SYSTEMS**

For heating of buildings made of light-weight construction principally the application of central heating is recommended (with radiators or by floor-heating).

Preparation of wall break-throughs and installation of fittings are similar to of water supply described in the previous chapter.

Using radiators for heating purposes the application of flexible mild steel pipes is recommended. The mild steel pipes enveloped with double plastic liner are perfectly corrosion-resistant. Therefore on the ground-floor the pipes can be sunk in the base concrete without any heat insulation and on the upper floors the pipes can be flush mounted into the floor-aligning BETONWOOD® boards having a thickness of 20 mm under the floor covering.

On the ground-floor and technics of construction and installation of the floor-heating system equals to the generally applied flush-mounting technics using cement-aestrich.

In case of built-in upper stories, because of restrictions derived from the construction, only dry building technics can be applied for flush-mounted floor-heating. One solution is offered by the application of heating lamellars and an other by the application of radiating aluminium foil.

After laying the heating pipes the construction must be covered with a BETONWOOD® board with 20 mm of thickness so as to avoid the harmful overloading of the plastic pipes by the walking surface and active load.

As a covering for the walking surface broadloom carpet, plastic covering, and tile covering embedded in flexible adhesive can be recommended.

# Beton Wood

## Range of BetonWood® product



**BetonWood®**



**BetonTherm®**



**BetonSanded®  
Tongue and Groove**

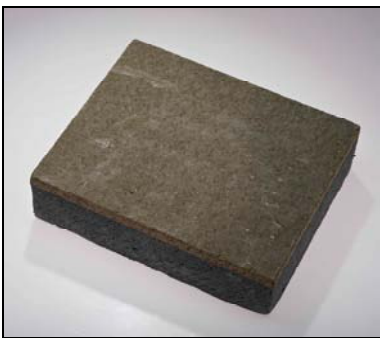

**BetonStyr®**



**BetonStone®**



**BetonStyr®**



**BetonRadiant®**



**BetonCork®**



**BetonEco®**

[info@BetonWood.com](mailto:info@BetonWood.com)  
[www.BetonWood.com](http://www.BetonWood.com)

 : **betonwood**